

AUG 25 - SEPT 4, 2023



**Colorado
State Fair**

MOUNTAINS OF FUN

**2023 4-H STATE
CHAMPIONSHIP HORSE SHOW**

**PATTERN
BOOK**

Colorado State Fair 4-H Horse Show

English Showmanship (Level II All Ages)

www.HorseShowPatterns.com

www.HorseShowPatterns.com

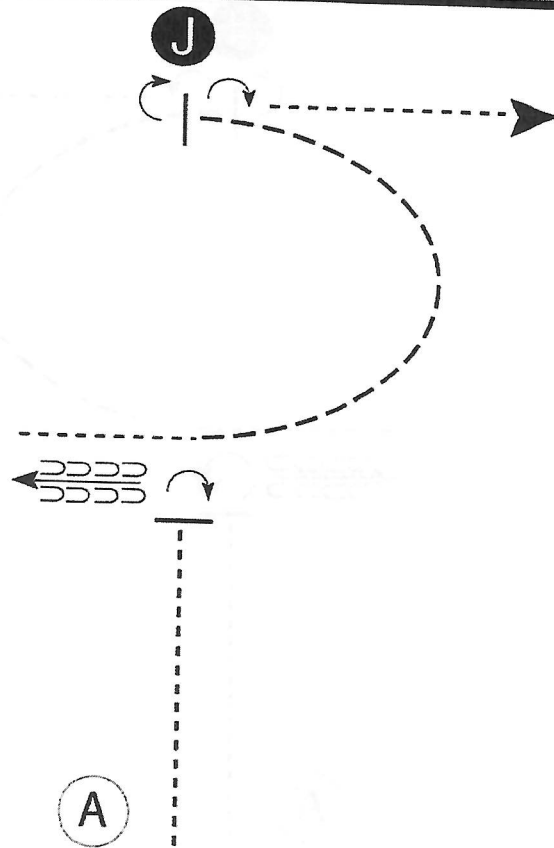

Be ready at A.

1. When acknowledged, walk half way to Judge.
2. Stop and perform a 1/4 turn.
3. Back approximately one horse length.
4. Walk until even with Judge.
5. Trot in a half circle until even with Judge.
6. Perform a 1/4 turn, stop and set up for inspection.
7. When dismissed, perform a 1/4 turn and walk straight away from Judge.

Walk	-----
Trot	- - - - -
Back	← ← ← ← ←
Marker	Ⓟ
Judge	Ⓝ

Follow the instructions of your ring steward.

Pattern Provided by:
Tiffany Mead

[S/2-80]

Colorado State Fair 4-H Horse Show

English Showmanship (Levels III & IV All Ages)

www.HorseShowPatterns.com

www.HorseShowPatterns.com

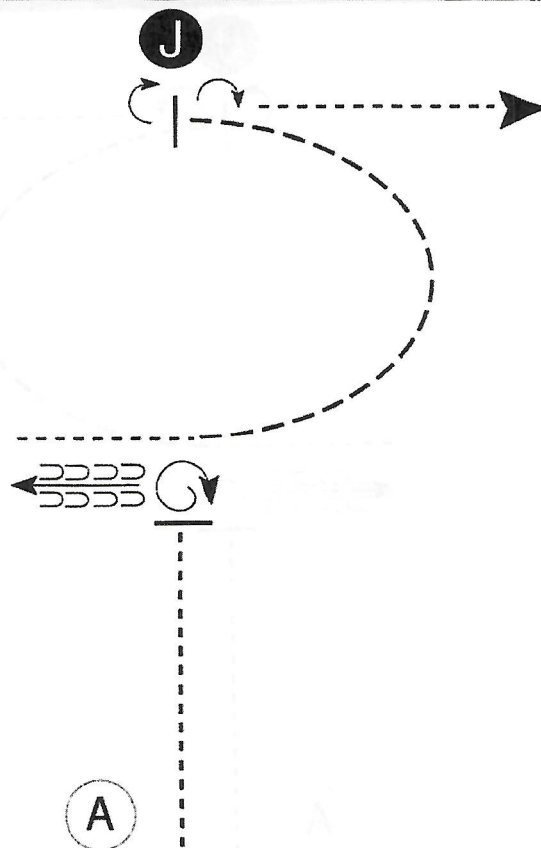

Be ready at A.

1. When acknowledged, walk half way to Judge.
2. Stop and perform a 1 1/4 turn.
3. Back approximately one horse length.
4. Walk until even with Judge.
5. Trot in a half circle until even with Judge.
6. Perform a 1/4 turn, stop and set up for inspection.
7. When dismissed, perform a 1/4 turn and walk straight away from Judge.

- Walk -----
- Trot - - - - -
- Back ← ㄩㄩㄩㄩ
- Marker (B)
- Judge (J)

Follow the instructions of your ring steward.

[S/3-80]

Pattern Provided by:

Tiffany Mead

Colorado State Fair 4-H Horse Show

English Equitation (Level II All Ages)

w w w . H o r s e S h o w P a t t e r n s . c o m

w w w . H o r s e S h o w P a t t e r n s . c o m

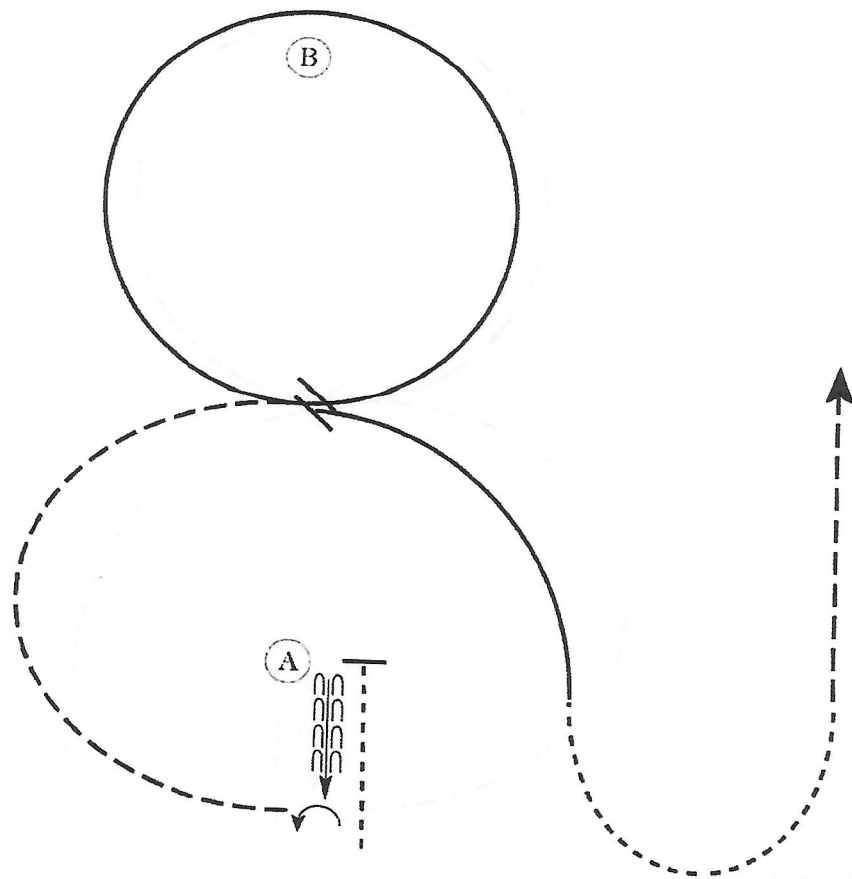

Be ready before A.

1. Walk to A. Back approximately one horse length the perform a 1/4 turn on the forehand left.
2. Posting trot on the left diagonal to center
3. Canter a circle around B on the left lead.
4. Change leads in the center and center on the right lead until even with A.
5. Walk a half circle.
6. Posting trot on the right diagonal to exit.

Follow the instructions of your ring steward.

Walk	-----
Trot	- - - - -
Extended Trot	-----
Canter	-----
Leg Yield	
Lead Change	
Back	←←←←←
Marker	⊙ B
Sidepass	←←
Hand Gallop	-----

Pattern Provided by:

Tiffany Mead

[HSE/2-72]

Colorado State Fair 4-H Horse Show

English Equitation (Levels III & IV All Ages)

www.HorseShowPatterns.com

www.HorseShowPatterns.com

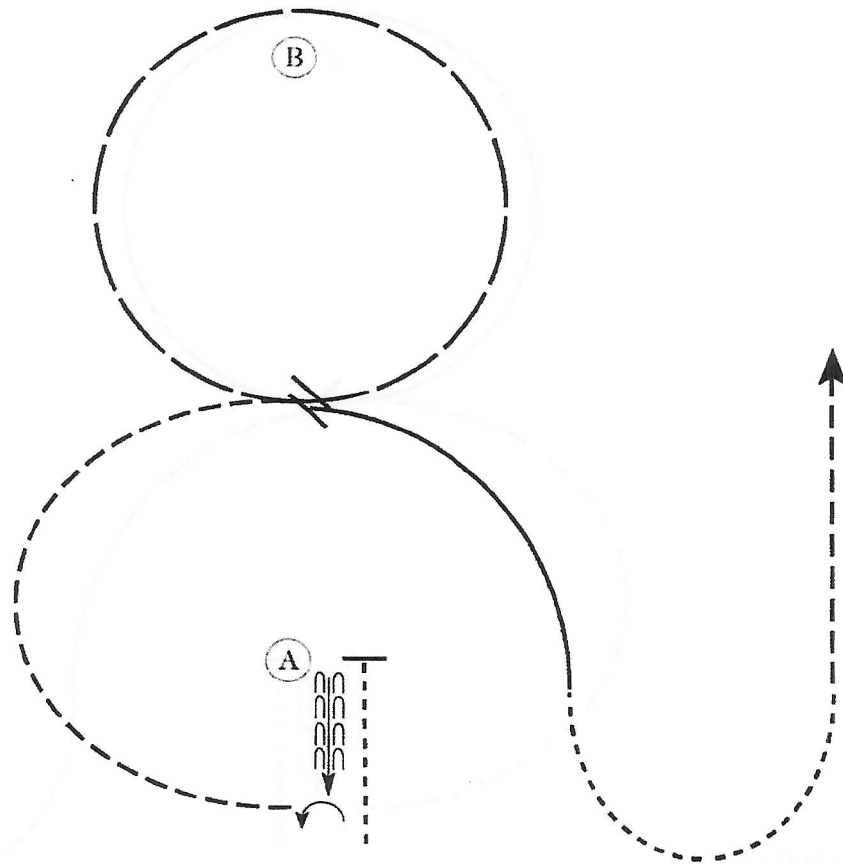

Be ready before A.

1. Walk to A. Back approximately one horse length the perform a 1/4 turn on the forehand left.
2. Posting trot on the left diagonal to center
3. Hand gallop a circle around B on the left lead.
4. Change leads in the center and center on the right lead until even with A.
5. Walk a half circle.
6. Posting trot on the right diagonal to exit.

Follow the instructions of your ring steward.

Walk	-----
Trot	- - - - -
Extended Trot	— — — — —
Canter	— — — — —
Leg Yield	
Lead Change	— / —
Back	← ← ← ← ←
Marker	⊙
Sidepass	← ←
Hand Gallop	— — — — —

[HSE/3-72]

Pattern Provided by:

Tiffany Mead

English Control Level 2 Pattern D

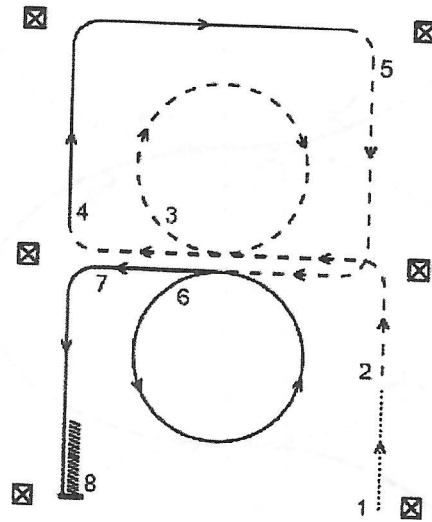

Walk: Canter: _____
 Back: ////////////// Trot: - - - - -

1. Normal walk
2. Rising trot halfway between cones
3. Change diagonal then circle right, rising trot
4. Canter right lead
5. Sitting trot
6. Canter left lead, circle left
7. Continue canter left lead
8. Halt and back one horse length

Leave the arena on a loose rein at the free walk.

480. Pattern 2 – Level III and IV English Control

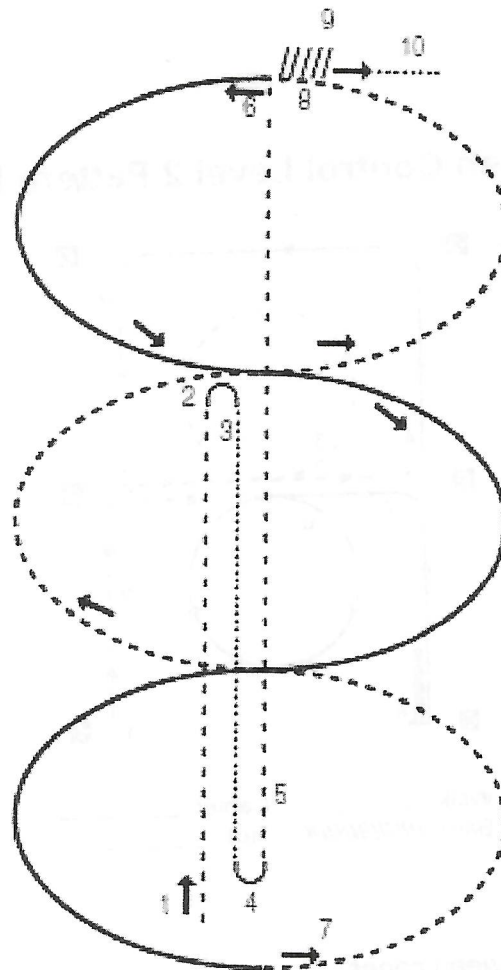

Walk: Canter: _____
 Back: //////////////// Trot: - - - - -

1. Sitting trot.
2. Halt, half turn (180 degrees) right on haunches.
3. Normal walk.
4. Halt, half turn (180 degrees) left on haunches.
5. Lengthen trot rising.
6. Canter serpentine with appropriate changes of lead, simple or flying.
7. Rising trot serpentine with change of diagonals.
8. Halt.
9. Back.
10. Leave arena on a loose rein at the free walk.

Colorado State Fair 4-H Horse Show

Hunter Hack (Levels III & IV All Ages)

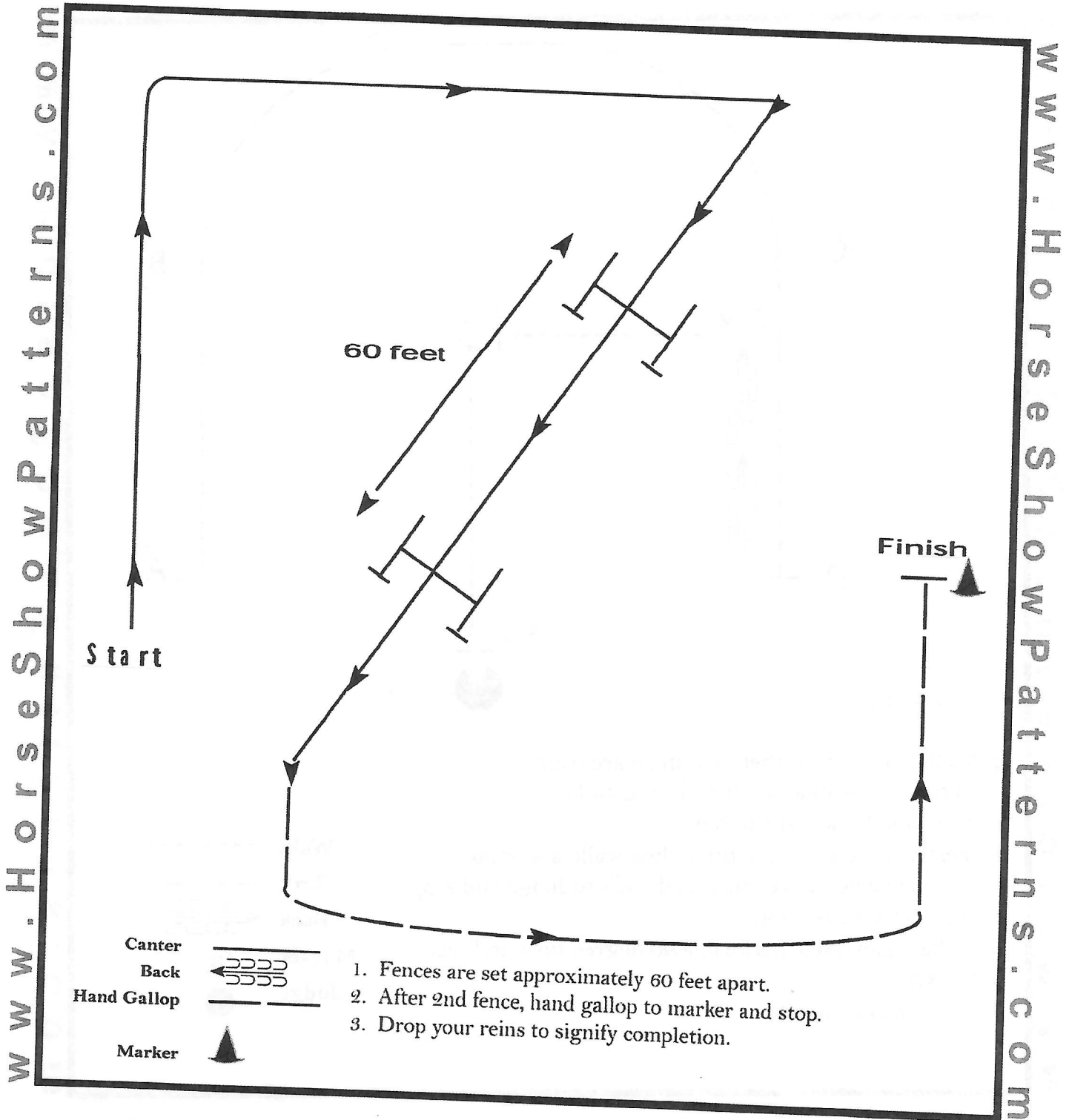

Pattern Provided by:
Tiffany Mead

[HH/60-17]

Colorado State Fair 4-H Horse Show

Western Showmanship (Level II All Ages)

www.HorseShowPatterns.com

www.HorseShowPatterns.com

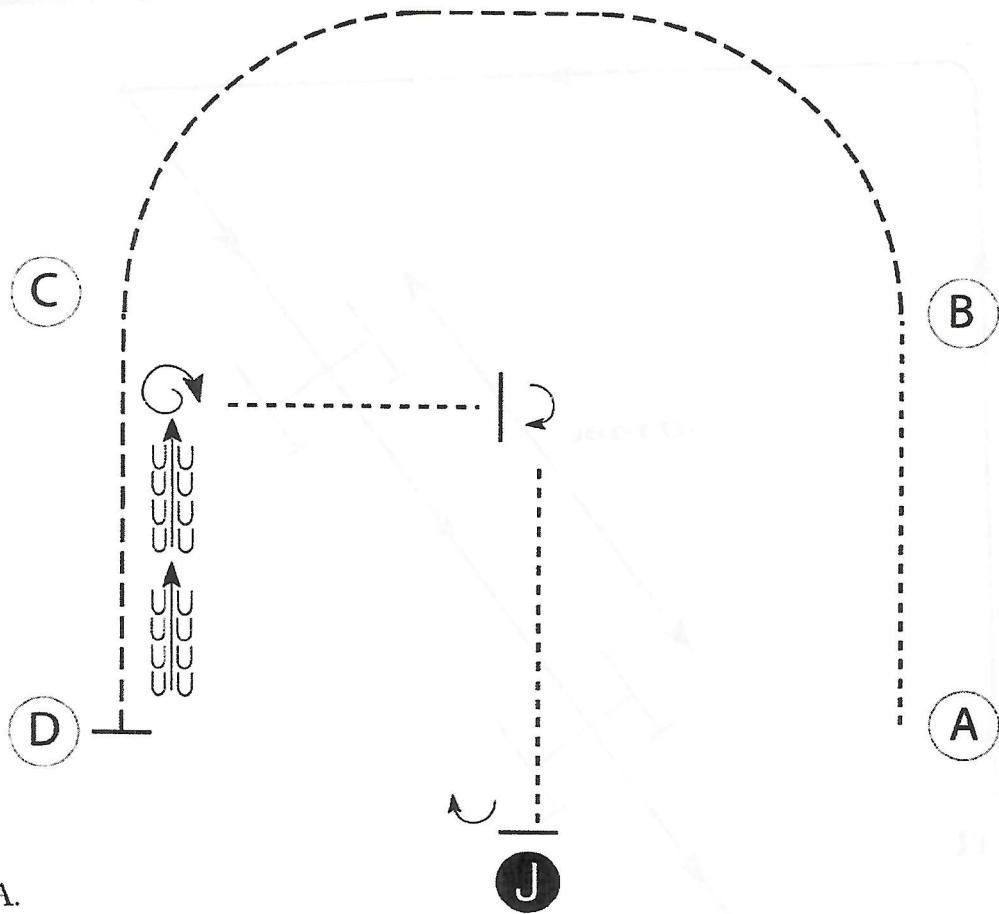

Be ready at A.

1. Walk from A to B then trot in an arc from B to C. Continue the trot from C to D.
2. Stop and back eight to ten feet.
3. Perform a 270 degree turn, then walk, and stop.
4. Perform a 90 degree turn and walk to Judge and stop.
5. Set up for inspection.
6. When dismissed, perform a 90 degree turn and trot to exit.
7. Pattern is complete.

- Walk -----
- Trot - - - - -
- Back ← ← ← ← ←
- Marker (B)
- Judge (J)

[S/1-96]

Pattern Provided by:

Tiffany Mead

©2020 HorseShowPatterns.com. All Rights Reserved.

Colorado State Fair 4-H Horse Show

Western Showmanship (Levels III & IV All Ages)

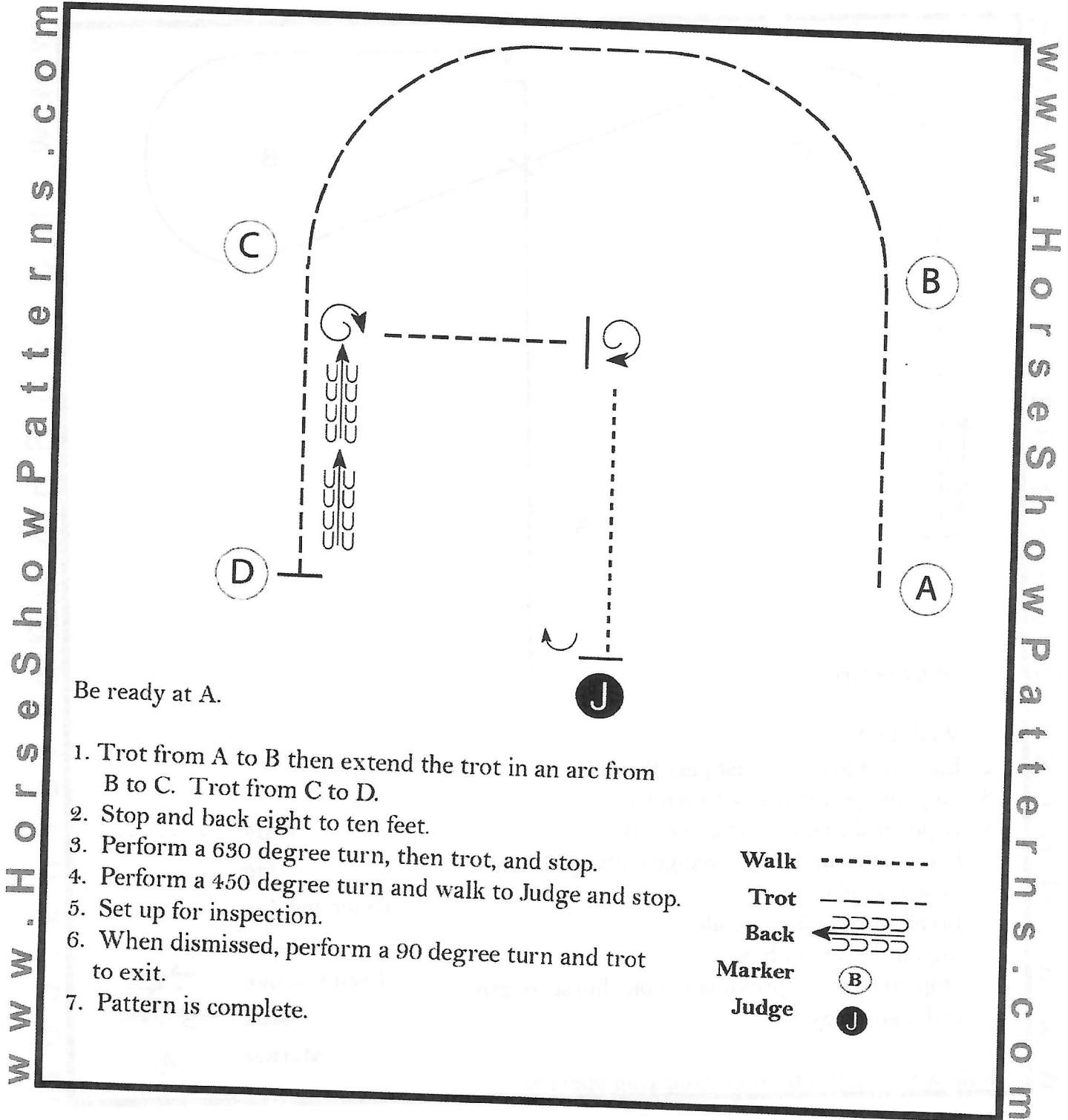

Be ready at A.

1. Trot from A to B then extend the trot in an arc from B to C. Trot from C to D.
2. Stop and back eight to ten feet.
3. Perform a 630 degree turn, then trot, and stop.
4. Perform a 450 degree turn and walk to Judge and stop.
5. Set up for inspection.
6. When dismissed, perform a 90 degree turn and trot to exit.
7. Pattern is complete.

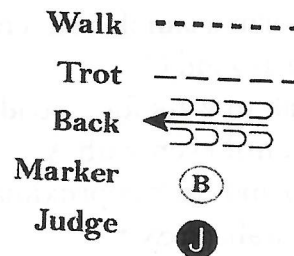

Pattern Provided by:
Tiffany Mead

[S/3-96]

Colorado State Fair 4-H Horse Show

Western Horsemanship (Level II All Ages)

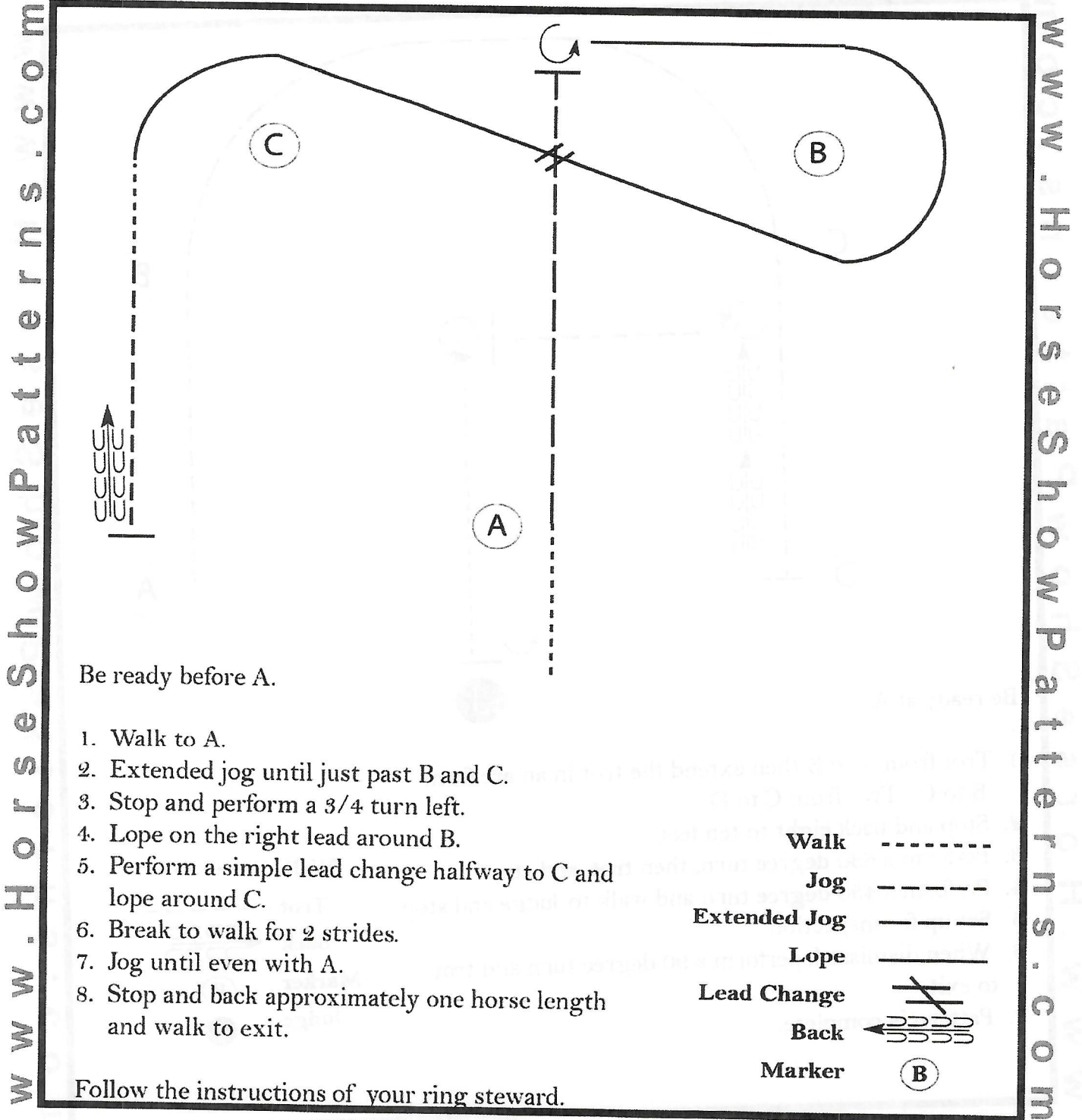

Pattern Provided by:

Tiffany Mead

©2020 HorseShowPatterns.com. All Rights Reserved.

[WH/2-91]

Colorado State Fair 4-H Horse Show

Western Horsemanship (Levels III & IV All Ages)

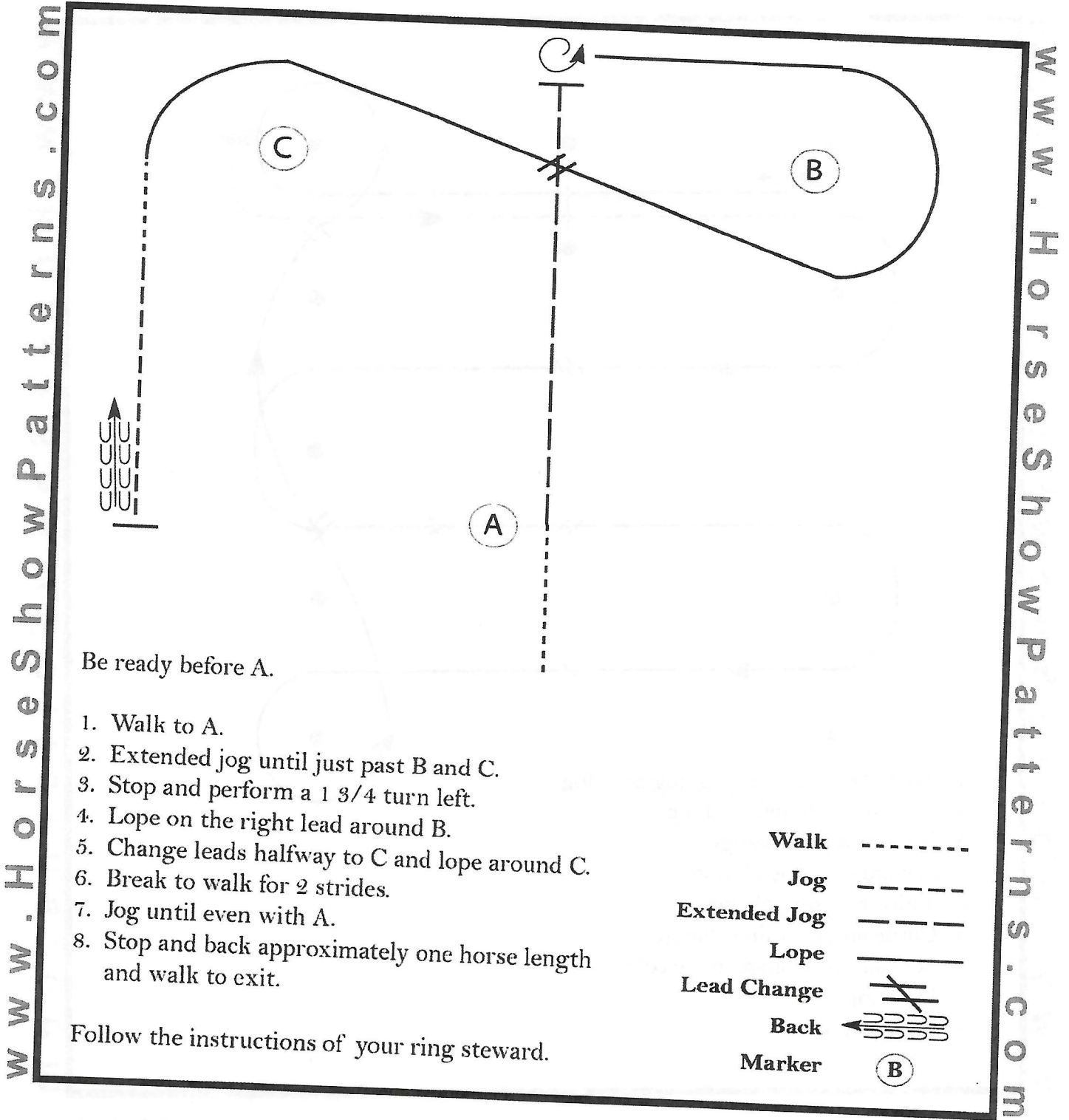

Pattern Provided by:
Tiffany Mead

[WH/3-91]

Colorado State Fair 4-H Horse
Show
Western Riding (Level II All Ages)

w w w . H o r s e S h o w P a t t e r n s . c o m

w w w . H o r s e S h o w P a t t e r n s . c o m

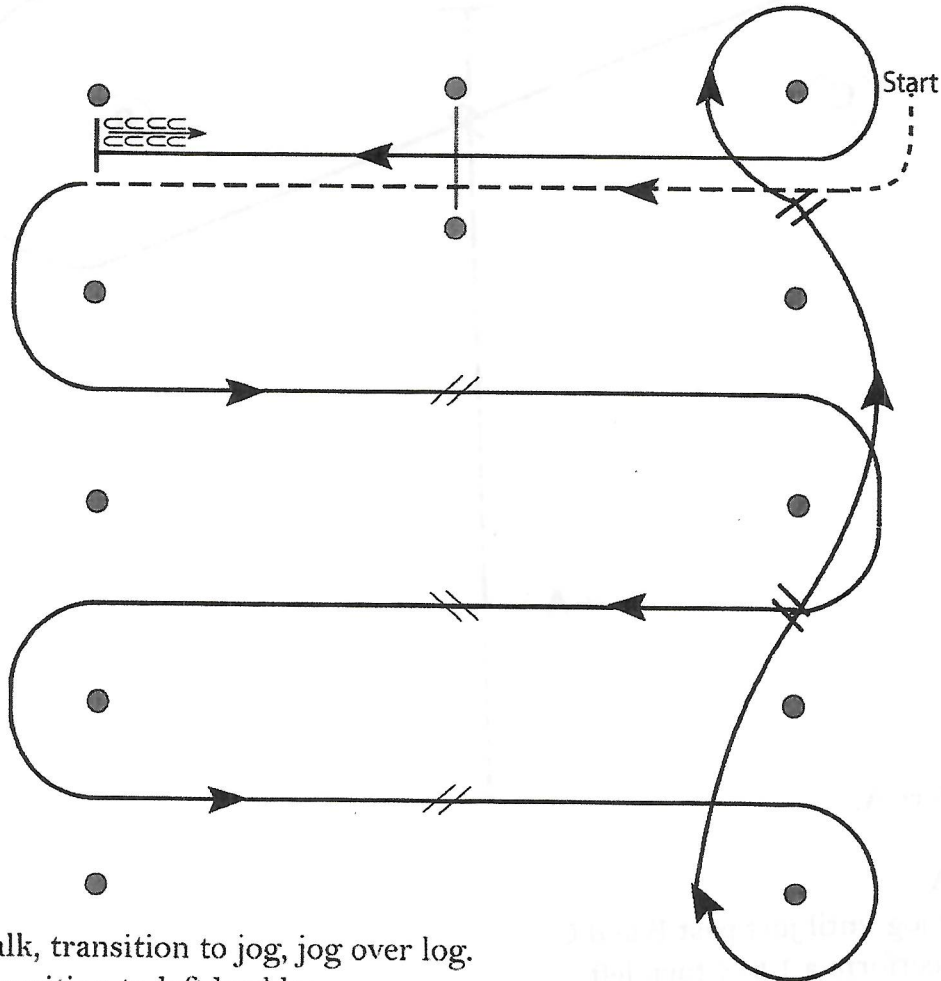

1. Walk, transition to jog, jog over log.
2. Transition to left lead lope.
3. First crossing change.
4. Second crossing change.
5. Third crossing change.
6. Circle and first line change.
7. Second line change and circle.
8. Lope log.
9. Stop and back.

Pattern Provided by:

Tiffany Mead

©2020 HorseShowPatterns.com. All Rights Reserved.

[WR/GP-2]

Colorado State Fair 4-H Horse
Show
Western Riding (Levels III & IV All Ages)

W W W . H o r s e S h o w P a t t e r n s . c o m

W W W . H o r s e S h o w P a t t e r n s . c o m

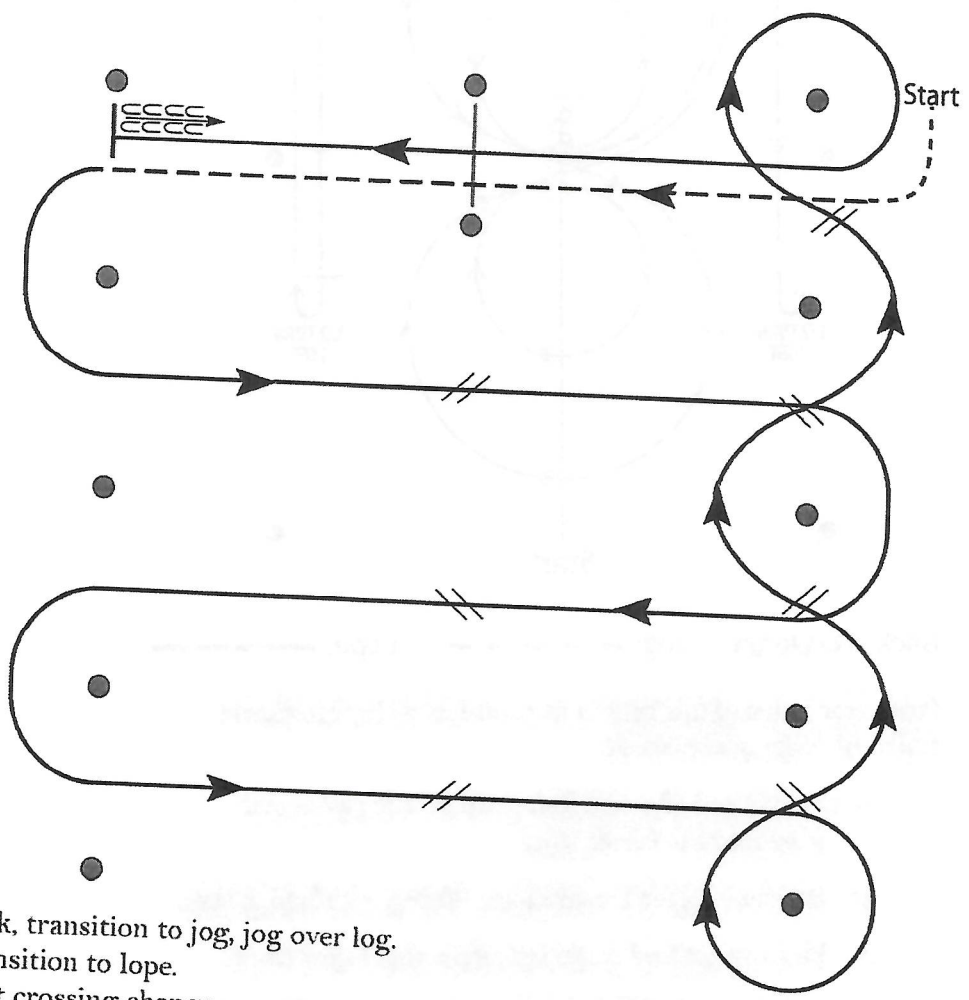

1. Walk, transition to jog, jog over log.
2. Transition to lope.
3. First crossing change.
4. Second crossing change.
5. Third crossing change.
6. Circle and first line change.
7. Second line change.
8. Third line change.
9. Fourth line change and circle.
10. Lope log.
11. Lope, stop and back.

Pattern Provided by:
Tiffany Mead

[WR/OP-2]

172. Pattern I - Level II

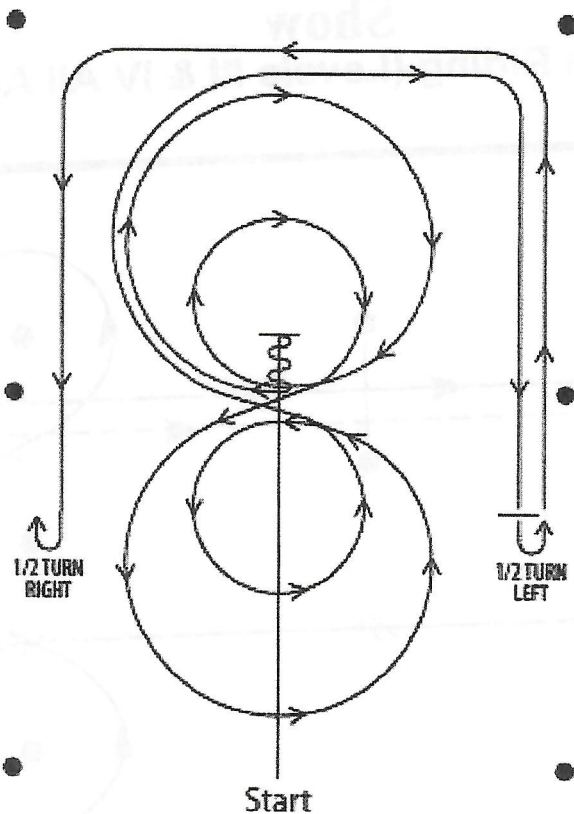

Back:  Jog:  Lope: 

Proper execution of this pattern requires Level II advancement skills. All stops are balanced.

1. Start at end of arena. Run down middle past center marker to a balanced stop.
2. Back at least ten feet to center. 90 degree turn to the left.
3. Pickup right lead, large fast circle, small slow circle.
4. Simple lead change to left, large fast circle, small slow circle.
5. Simple lead change to right, do not close this circle.
6. Run around end of arena and down the side (approximately 20 feet from fence) past center marker and come to a balanced stop.
7. Turn 180 degrees on the haunches to the left.
8. Continue back down side and end of arena to other side (approximately 20 feet from fence) go past center marker and come to a balanced stop.
9. Turn 180 degrees on the haunches to the right. Hesitate to complete pattern.

Reining Level III & IV Pattern 5 (NRHA Pattern 7)

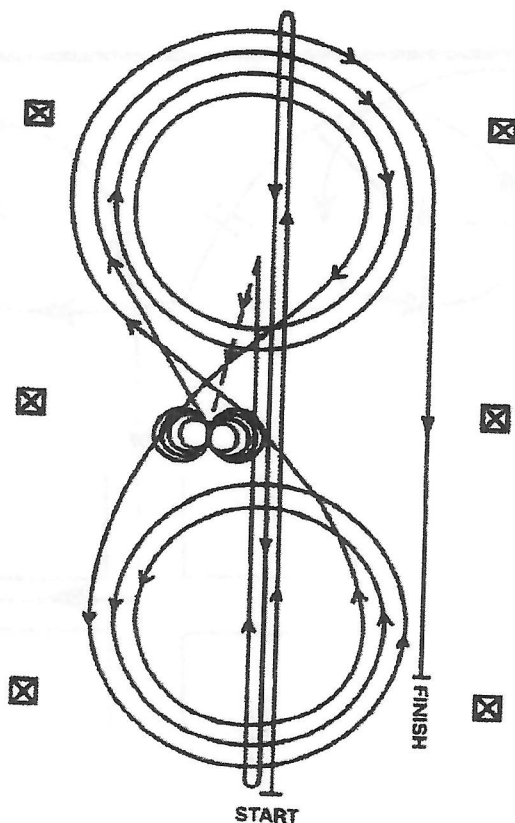

1. Run at speed to the far end of the arena past the end marker and do a left rollback—no hesitation.
2. Run to the opposite end of the arena past the end marker and do a right rollback—no hesitation.
3. Run past the center marker and do a sliding stop. Back up to the center of the arena or at least ten feet. Hesitate.
4. Complete four spins to the right. Hesitate.
5. Complete four and one-quarter spins to the left so that horse is facing left wall or fence. Hesitate.
6. Beginning on the right lead, complete three circles to the right; the first two circles large and fast; the third circle small and slow. Change leads at the center of the arena.
7. Complete three circles to the left; the first two circles large and fast; the third circle small and slow. Change leads at the center of the arena.
8. Begin a large fast circle to the right but do not close this circle. Run straight down the right side of the arena past the center marker and do a sliding stop at least twenty feet from the wall or fence. Hesitate to demonstration completion of the pattern.

Rider must drop bridle to the designated judge.

Colorado State Fair 4-H Horse Show

Trail (Level II All Ages)

www.HorseShowPatterns.com

www.HorseShowPatterns.com

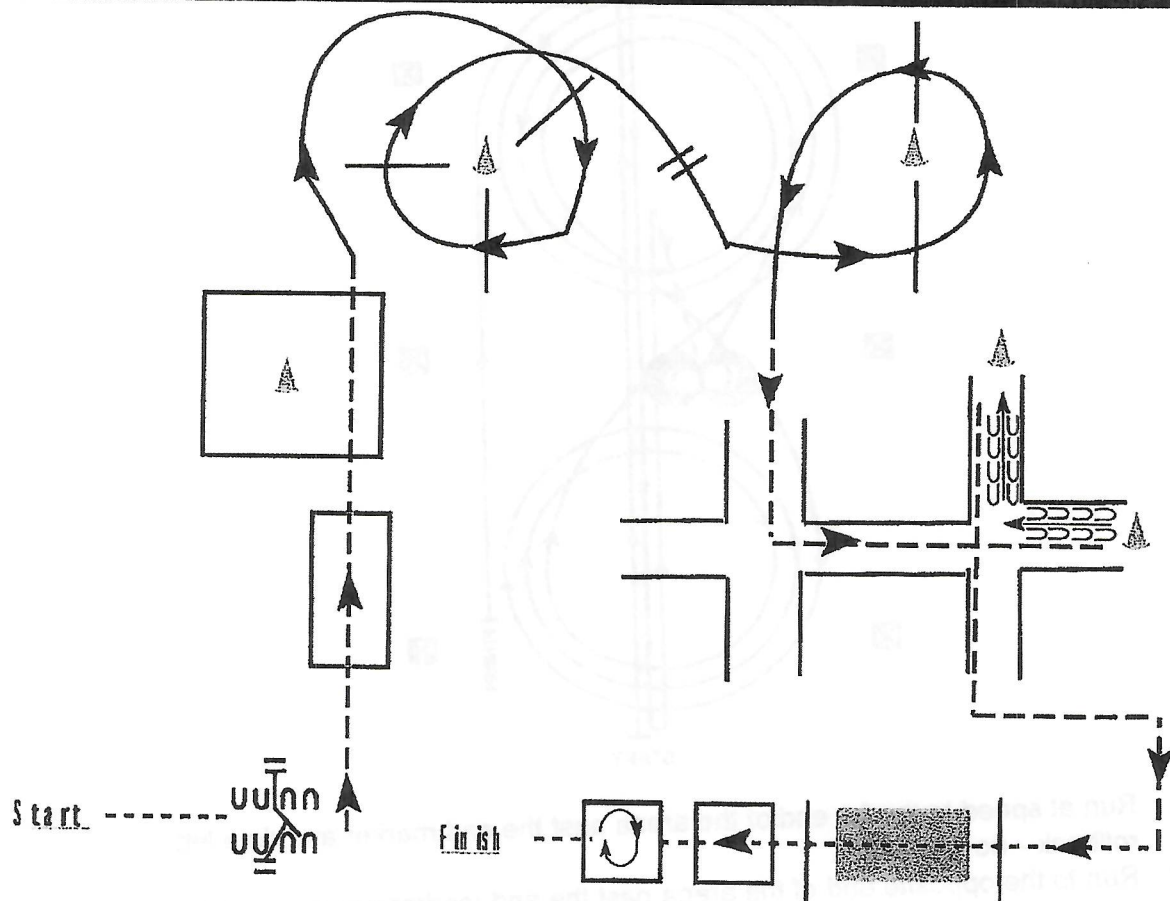

1. Work gate with left hand.
2. Jog thru box and a circle around the cone in second box.
3. Lope on the right lead over poles.
4. Perform a simple lead change.
5. Lope on the left lead over poles.
6. Jog into chute. Back the L.
7. Jog out of chute to walk overs.
8. Walk over poles, over bridge and into box.
9. Turn 360 degrees (either direction) and walk out to finish.

Walk	-----
Jog	- - - - -
Extended Jog	- - - - -
Lope	_____
Leg Yield	
Lead Change	///
Back	←←←←←
Marker	Ⓚ
Sidepass	←←←←←

[T/2-33]

Pattern Provided by:
Show Management

Colorado State Fair 4-H Horse Show

Trail (Levels III & IV All Ages)

HorseShowPatterns.com

www.HorseShowPatterns.com

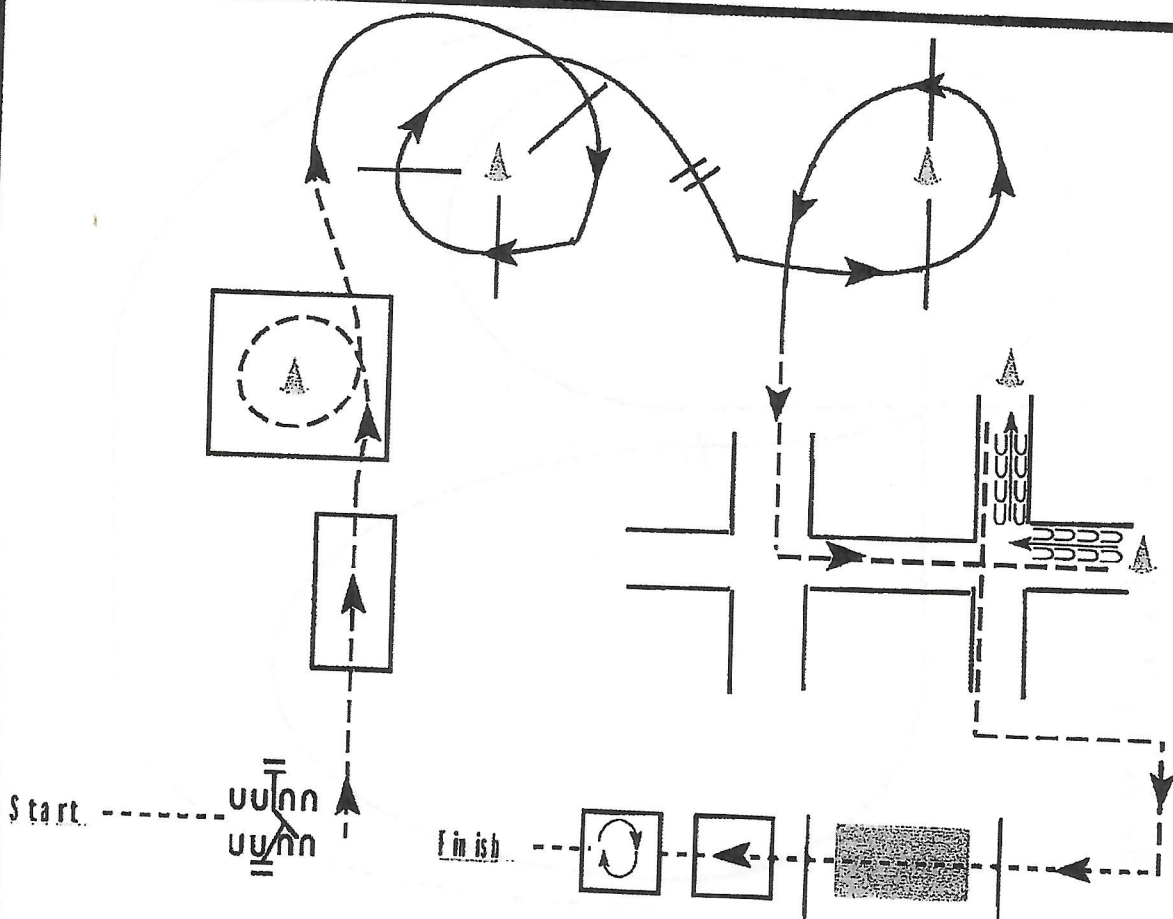

1. Work gate with left hand.
2. Jog thru box and a circle around the cone in second box.
3. Lope on the right lead over poles.
4. Perform a flying lead change.
5. Lope on the left lead over poles.
6. Jog into chute. Back the L.
7. Jog out of chute to walk overs.
8. Walk over poles, over bridge and into box.
9. Turn 360 degrees each direction (either direction first) and walk out to finish.

Walk	-----
Jog	-----
Extended Jog	-----
Lope	-----
Leg Yield	
Lead Change	↗ ↘
Back	←←←←
Marker	Ⓚ
Sidepass	←→

Pattern Provided by:

[T/3-33]

Show Management

Colorado State Fair 4-H Horse Show

Ranch Riding (Level II All Ages)

w w w . H o r s e S h o w P a t t e r n s . c o m

w w w . H o r s e S h o w P a t t e r n s . c o m

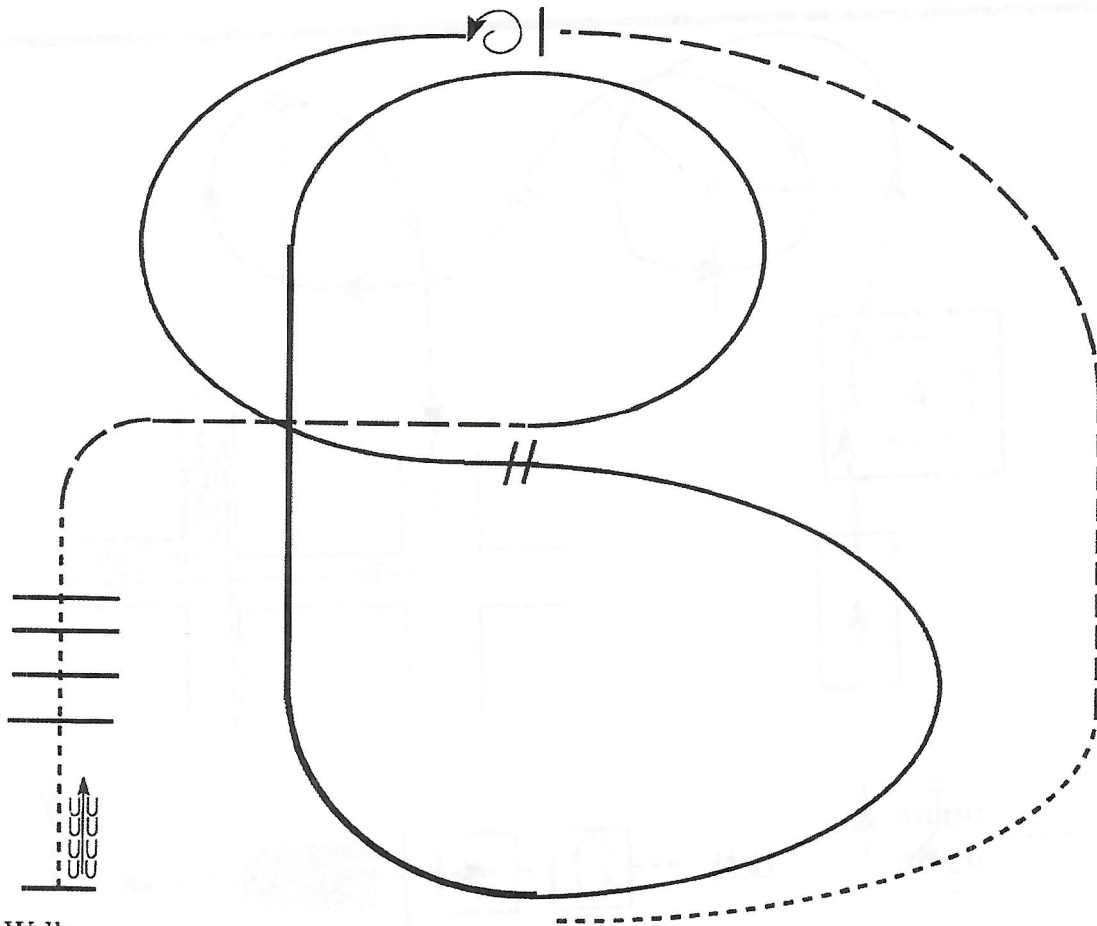

1. Walk
2. Trot
3. Extend the trot, at the top of the arena, stop
4. 360 degree turn to the left
5. Left lead 1/2 circle, lope to the center
6. Change leads (simple or flying)
7. Right lead 1/2 circle
8. Extended lope up the long side of arena (right lead)
9. Collect back to a lope around the top of the arena and back to center
10. Break down to an extended trot
11. Walk over poles.
12. Stop and back

Walk	-----
Jog	- - - - -
Extended Jog	-----
Lope	-----
Lead Change	//
Back	← ← ← ← ←
Marker	Ⓚ

Pattern Provided by:

Tiffany Mead

[RR/1]

Colorado State Fair 2023
4H Ranch Trail Level 2
Pattern by: Julie Hayes

1. Walk Bridge
2. Trot Box
3. Right Lead Lope Poles
4. Work Gate Left Handed
5. Left Lead Lope Poles
6. Extended Trot through Hay Bales
7. Trot into Chute
8. Back "L" and Exit at a Walk

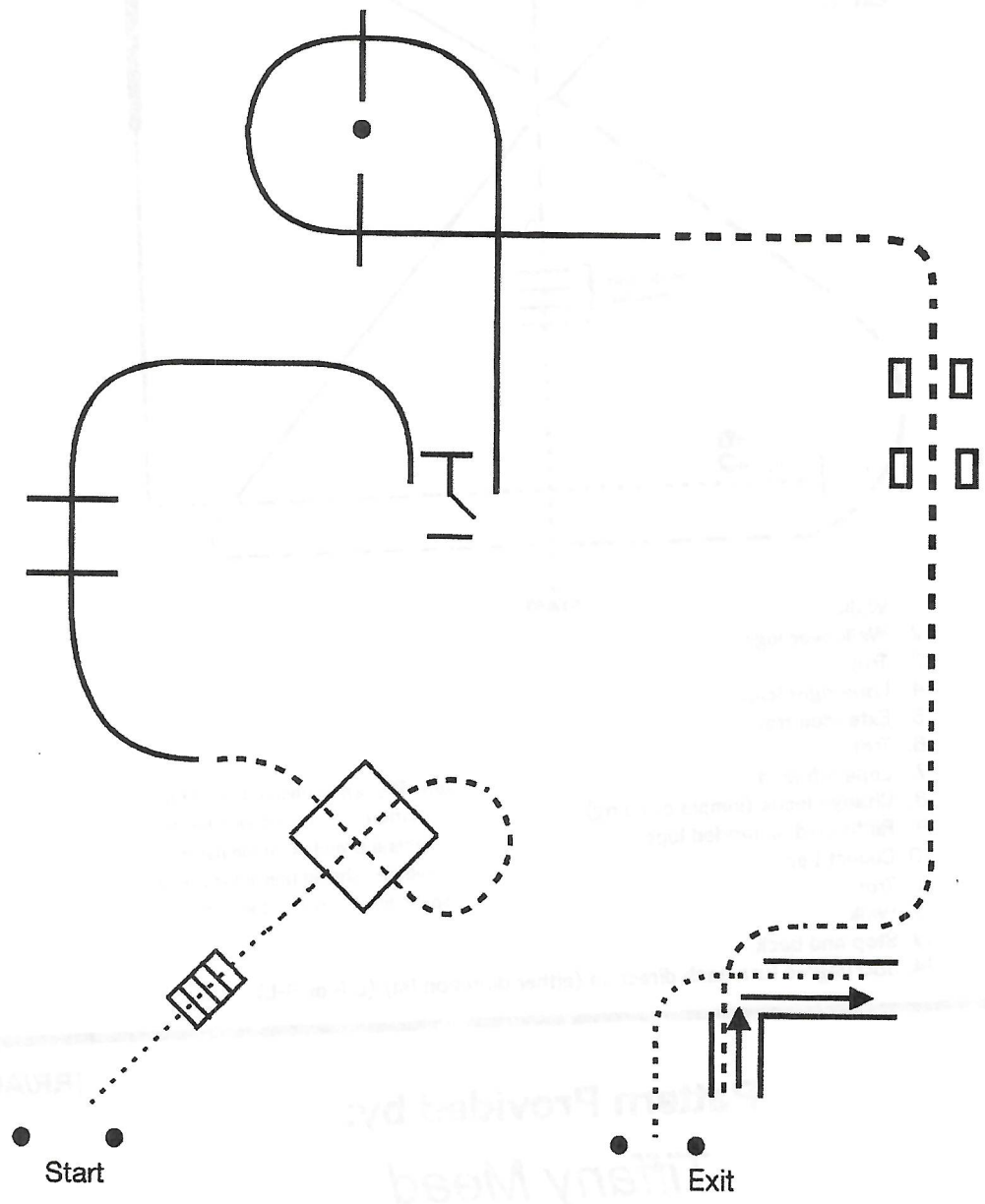

Colorado State Fair 2023
4H Ranch Trail Level 3/4
Pattern by: Julie Hayes

1. Walk Bridge
 2. Trot Box
 3. Right Lead Lope Poles
 4. Sidepass Log to Gate
 5. Work Gate Left Handed
 6. Left Lead Lope Poles
 7. Extended Trot through Hay Bales
 8. Drag Log to the Right
 9. Trot into Chute and Back "L"
- Exit at a Walk

